

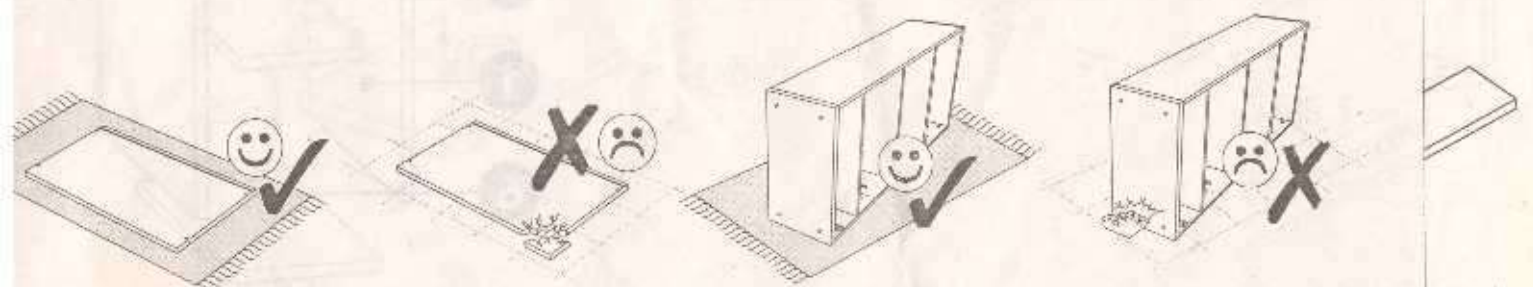

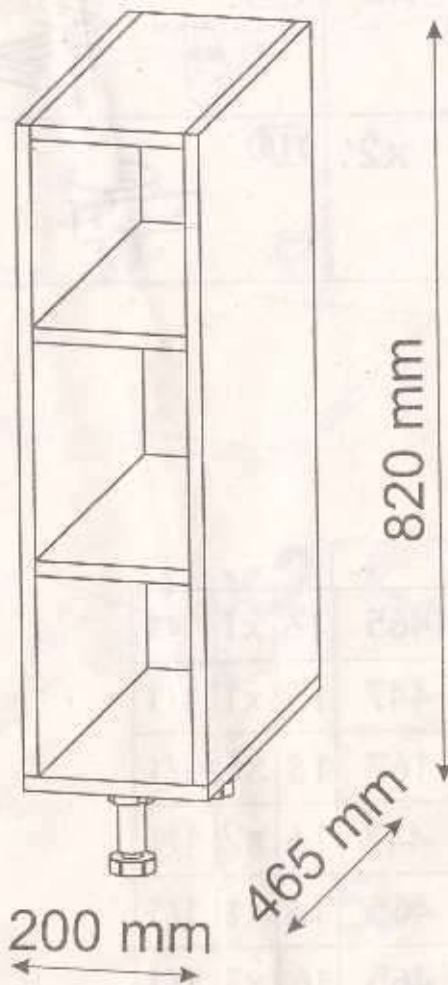

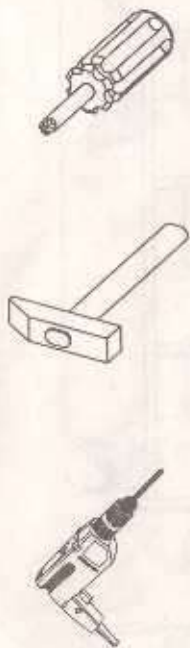





# CHARLOTTE 20 LC

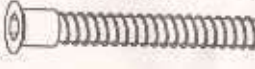

6 ▶

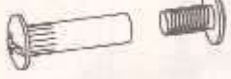
# CHARLOTTE 20 LC

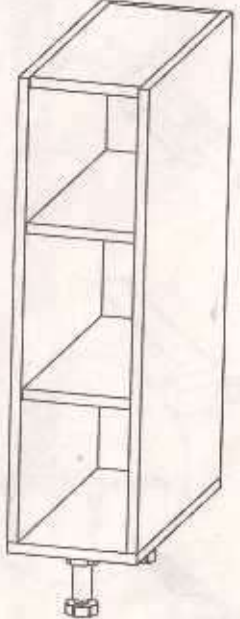
7 ▶

<b>A0</b> 8 x 32mm x10 	<b>B1</b> 17 x 50 mm x6 	<b>C2</b> x8 
<b>C7</b> 16 mm x8 	<b>D2</b> 3 x 30 mm x2 	<b>D10</b> 4 x 16 mm x10 
<b>H0</b> x2 	<b>K</b> 4mm x1 	
<b>T14</b> x2 	<b>T15</b> x1 	

8 ▶



<b>1</b>	704	465	16	x1	1/1
<b>2</b>	167	447	16	x1	1/1
<b>3</b>	704	167	16	x1	1/1
<b>4</b>	167	447	16	x2	1/1
<b>5</b>	704	465	16	x1	1/1
<b>6</b>	200	465	16	x1	1/1
					1/1

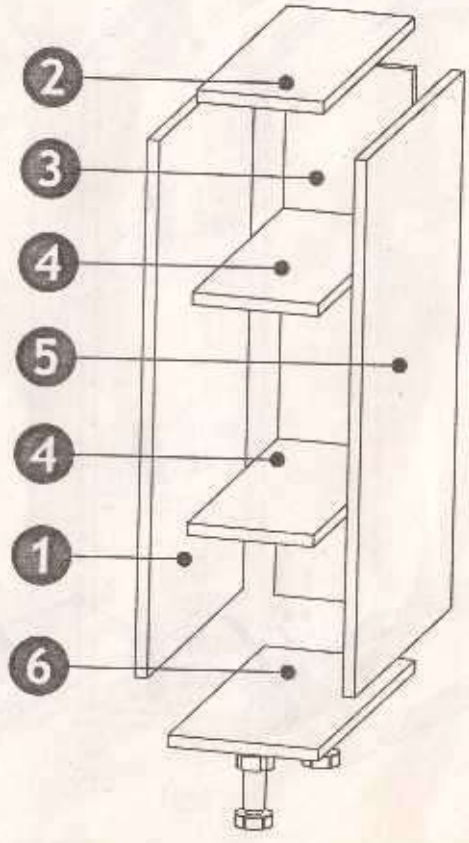

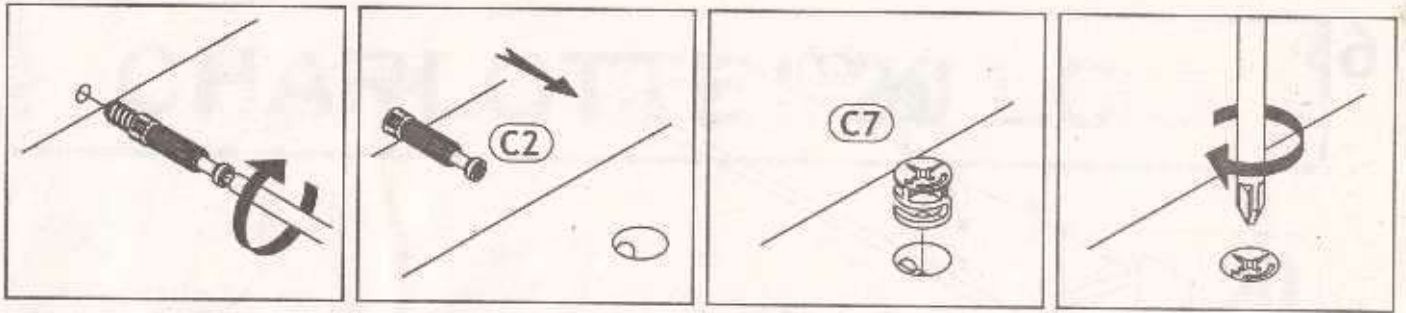

1 ▶

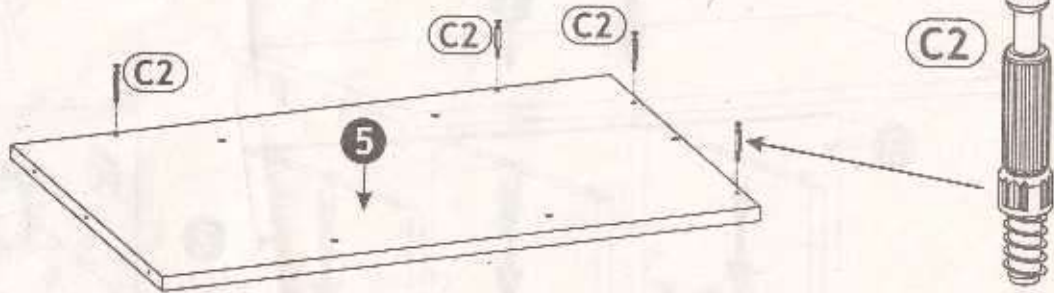

2 ▶

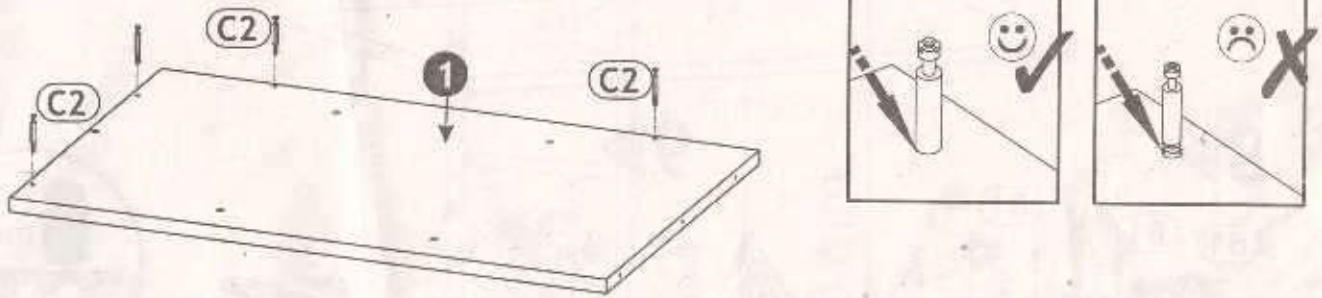

3 ▶

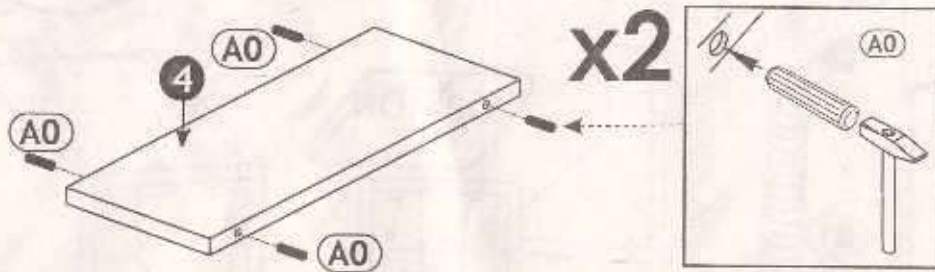

4 ▶

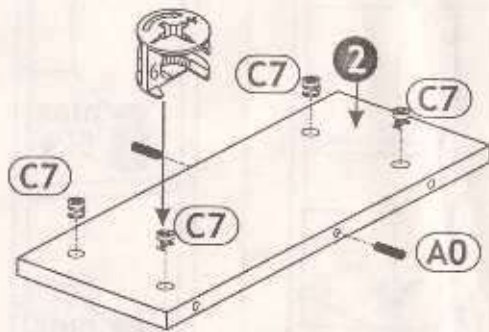

5 ▶

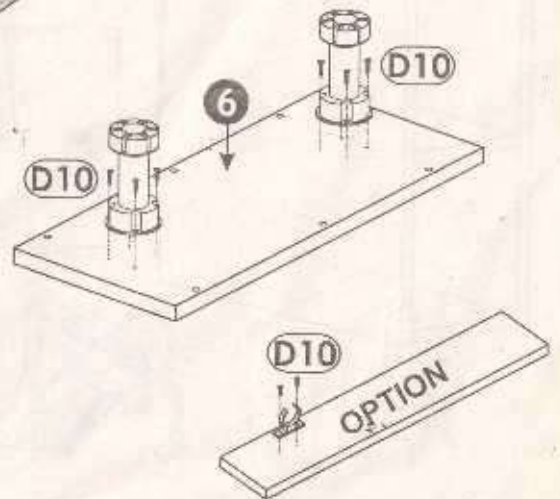

6 ▶

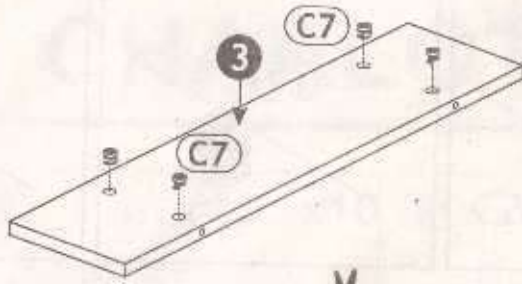

7 ▶

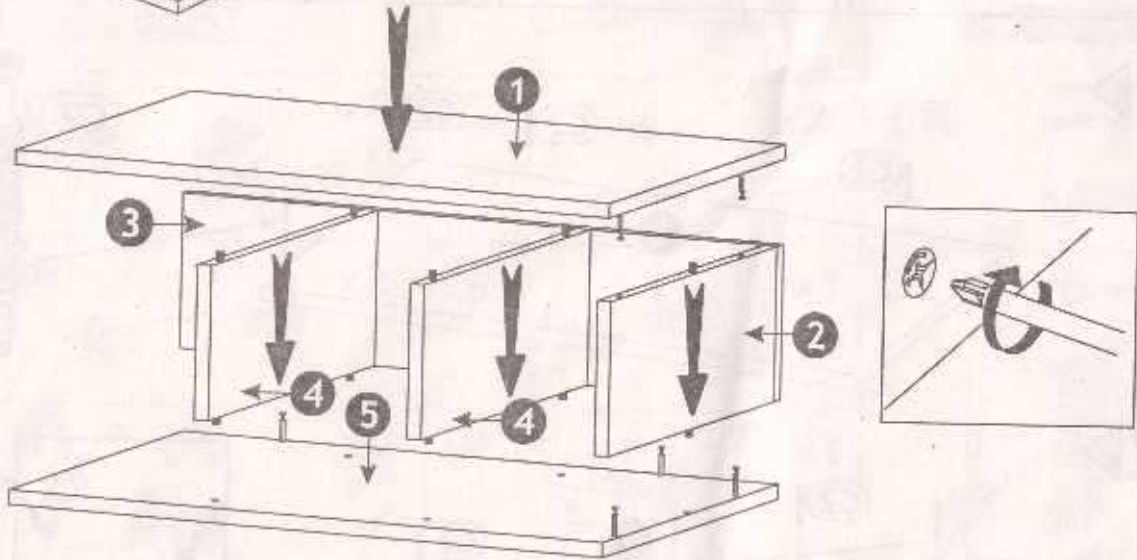

8 ▶

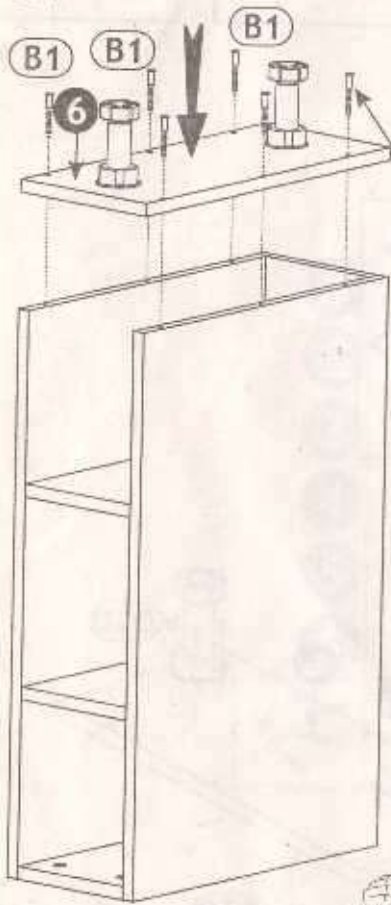

9 ▶

